



DENTISTA INSTRUMENTS

Manufacturer & Expoters of Surgical & Dental Implants

DENTAL IMPLANT KITS



www.dentistainstruments.com

DENTAL INSTRUMENTS | DENTAL IMPLANT TOOLS | ORTHODONTIC INSTRUMENTS

I N S T R U M E N T S

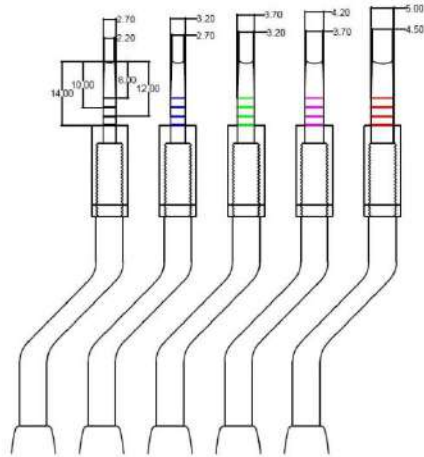

CODE: OST01

Osteotome Elevator (Concave) Kit of 5 PCS

- 1) Osteotome Elevator 2.7 mm w/Curved Handle (BLUE)
- 2) Osteotome Elevator 3.2 mm w/Curved Handle (RED)
- 3) Osteotome Elevator 3.7 mm w/Curved Handle (GREEN)
- 4) Osteotome Elevator 4.2 mm w/Curved Handle (YELLOW)
- 5) Osteotome Elevator 5.0 mm w/Curved Handle (BLACK)
- 6) Mesh Cassette of 5 PCS (AUTOCLAVABLE)

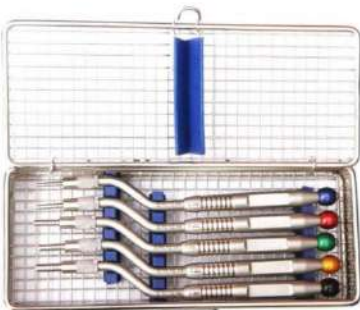

PDL / PERIOTOME LUXATING ELEVATORS KIT

W/BLEU COATED POINTS

CODE: PDL01

DESCRIPTION:

- 1) Arrow Shape
- 2) 2.5 mm Distal
- 3) 2.5 mm Mesial
- 4) 4.0 mm Distal
- 5) 4.0 mm Mesial
- 6) 2.5 mm Curved
- 7) 2.5 mm Straight
- 8) Cassette of 7 PCS
(Autoclavable)

QUICK CODES:

- 1) Black
- 2) Blue
- 3) Sky Blue
- 4) Green
- 5) Yellow
- 6) Orange
- 7) Red





CODE: TRD01

TREPINE DRILLS / BURS (COLOR COATED)

- 1) Trephine Drill \varnothing 3.0 mm [Standard]
- 2) Trephine Drill \varnothing 4.0 mm [Standard]
- 3) Trephine Drill \varnothing 5.0 mm [Standard]
- 4) Trephine Drill \varnothing 6.0 mm [Standard]
- 5) Trephine Drill \varnothing 7.0 mm [Standard]
- 6) Trephine Drill \varnothing 8.0 mm [Standard]
- 7) Trephine Drill \varnothing 9.0 mm [Standard]
- 8) Trephine Drill \varnothing 10.0 mm [Standard]



**TREPINE DRILLS KIT OF 8 PCS
W / PANEL**



TISSUE PUNCHES + S/S PANEL

- 1) Tissue Punch (Open Rotary) 3.0 mm
- 2) Tissue Punch (Open Rotary) 3.5 mm
- 3) Tissue Punch (Open Rotary) 4.0 mm
- 4) Tissue Punch (Open Rotary) 4.5 mm
- 5) Tissue Punch (Open Rotary) 5.0 mm
- 6) Tissue Punch (Open Rotary) 5.5 mm
- 7) Tissue Punch (Centered Rotary) 4.0 mm
- 8) Tissue Punch (Centered Rotary) 5.0 mm





SURGICAL DRILL KIT

- 1) Drills x 7 PCS
Sizes: 2.0mm, 2.5mm, 2.8mm, 3.2mm, 3.65mm, 4.2mm & 5.2mm
- 2) Parallel Pins x 2 PCs Short and Long
- 3) Ratchet Driver x 2 PCs long, Hex 2.45mm
- 4) Ratchet Driver x 2 PCs long, Hex 1.25mm
- 5) Motor Mount x 1 PC Hex 2.45mm
- 6) Motor Mount x 1 PC Hex 1.25mm
- 7) Ratchet



BONE COMPRESSION KIT

- 1) COMPRESS SCREW 2.8/4.2mm
- 2) COMPRESS SCREW 2.4/3.6mm
- 3) COMPRESS SCREW 2/3.3mm
- 4) CONVEX CMOMPRESS SCREW 1.6/2.8mm
- 5) CONCAVE SINUS SCREWS 3mm
- 6) CONCAVE SINUS SCREWS 3.50mm
- 7) CONCAVE SINUS SCREWS 4.00 mm
- 8) RATCHET ADOPTER
- 9) RATCHET ADOPTER
- 10) CENTER PUNCH
- 11) LONG MOTOR MOUNT ADOPTER
- 12) HAND SCREW DRIVER
- 13) RATCHET WRENCH



EXPANDER SCREW KIT

- 1) Expander Screws (5 PCs)
 - a) Screw Diameter 2.6mm 1.8/2.6,
 - b) Screw Diameter 3.0mm 2.0/3.0,
 - c) Screw Diameter 3.4mm 2.4/3.4,
 - d) Screw Diameter 3.8mm 2.7/4.8,
 - e) Screw Diameter 4.3mm 2.9/4.3
- 2) Drill 2.0 mm
- 3) Latch Adopter
- 4) Saw 7.0 mm
- 5) Saw 10.0 mm
- 6) Hand Driver
- 7) Wrench Extender
- 8) Pin/Guide
- 9) Ratchet Wrench



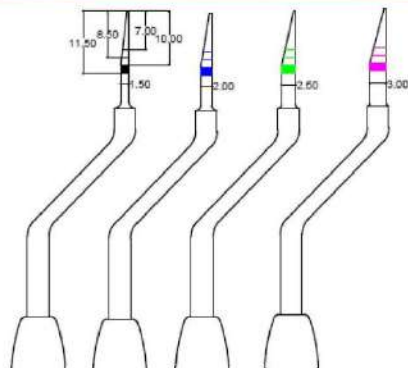

RIDGE SPLIT CHISEL OFFSET KIT

- 1) Ridge Split Chisel 1.5 mm
- 2) Ridge Split Chisel 2.0 mm
- 3) Ridge Split Chisel 2.5 mm
- 4) Ridge Split Chisel 3.0 mm





DENTISTA INSTRUMENTS

Manufacturer & Expoters of Surgical & Dental Implants

AESTHETIC KIT OF 7 PCS

WSTERLIZATION CASSETTE

- 1) Applica instrument
- 2) Applica Twist instrument
- 3) Modella Instrument
- 4) Condensa instrument
- 5) Fissura instrument
- 6) Misura instrument
- 7) Eccesso Instrument

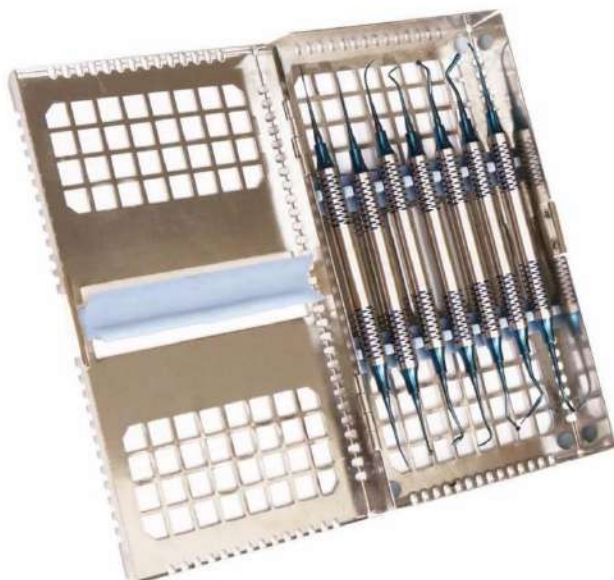



**GRACEY CURETTES SET OF 7
W/ PLASTIC TRAY**

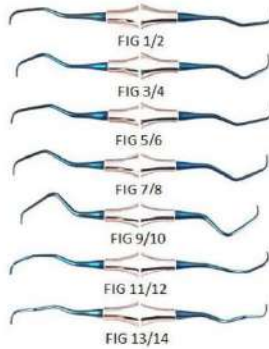
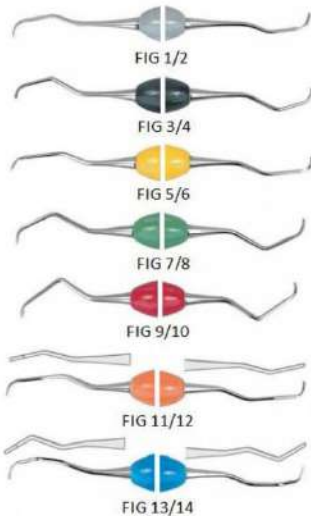

**GRACEY CURETTES SET OF 7
[W/ STERILIZATION CASSETTE]**

CODE-C: GRK03 (S/S Polished)

- 1) Gracey Fig. 1/2
- 2) Gracey Fig. 3/4
- 3) Gracey Fig. 5/6
- 4) Gracey Fig. 7/8
- 5) Gracey Fig. 9/10
- 6) Gracey Fig. 11/12
- 7) Gracey Fig. 13/14



**GRACEY CURETTES SET OF 7
W/ STERILIZATION CASSETTE**



DENTISTA INSTRUMENTS

Manufacturer & Expoters of Surgical & Dental Implants



SINUS LIFT CURETTES SET OF 6 [W/ STERILIZATION CASSETTE]

CODE-A: SNL01 (Coated)

CODE-B: SNL02 (Titanium)

CODE-C: SNL03 (S/S Polished)

- 1) SINUS-1
- 2) SINUS-2
- 3) SINUS-3
- 4) SINUS-4
- 5) SINUS-5
- 6) SINUS-6

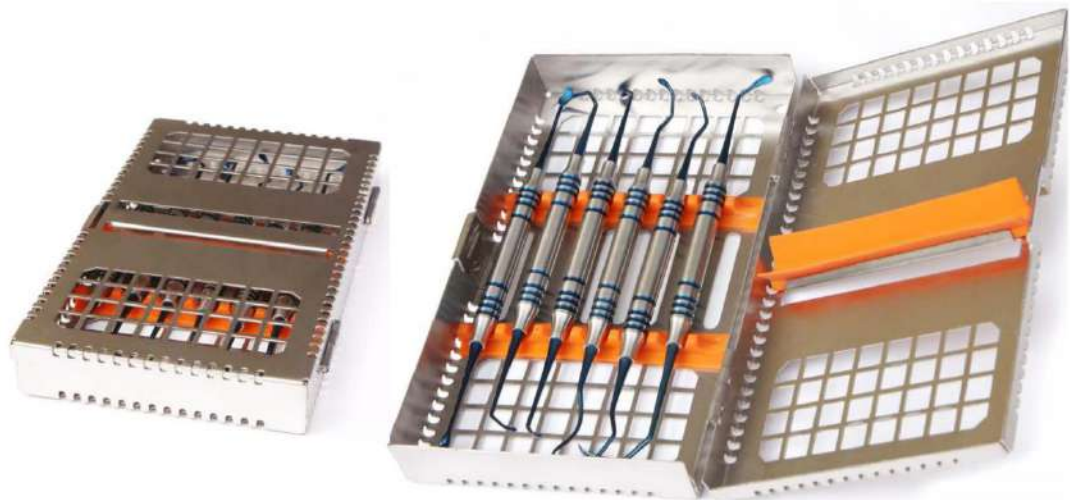

SINUS LIFT CURETTES SET OF 6 W/ STERILIZATION CASSETTE



CODE: BUR01

Bur Drills Marking

Burs drill speeds of 800-1500 RPM.

2.0 mm , 3.0 mm , 4.0 mm ,5.0 mm.

2.3 mm , 3.3 mm ,4.3 mm , 5.3 mm.

2.5 mm , 3.5 mm , 4.5 mm , 5.5 mm.

Finishers for Parallel Wall Implants.

Bur depth markings 8-20 mm



CODE: RTK01

ROOT ELEVATORS KIT OF 7 PCS

W/ LEATHER POUCH

- 1) APICAL ROOT ELEVATOR FIG. 301 STRAIGHT 2 MM
- 2) APICAL ROOT ELEVATOR FIG. 302 RIGHT
- 3) APICAL ROOT ELEVATOR FIG. 303 LEFT
- 4) APICAL ROOT ELEVATOR FIG. 304 STRAIGHT 3 MM
- 5) FLOHR ROOT ELEVATOR FIG. 09 (4 MM)
- 6) CRYER ROOT ELEVATOR FIG. 27 LEFT
- 7) CRYER ROOT ELEVATOR FIG. 28 RIGHT



CODE: RDK01

RUBBER DAM INSTRUMENTS KIT

W/ LEATHER POUCH

- 1) Rubber Dam Clamps Set of 9 (Sorted)
- 2) Rubber Dam Frame Adult
- 3) Rubber Dam Frame Child
- 4) Rubber Dam Plier Brewer/Palmer/Stockes
- 5) Ainsworth Rubber Dam Punch





DENTISTA INSTRUMENTS

Manufacturer & Expoters of Surgical & Dental Implants

MANUFACTURING UNIT

DENTISTA INSTRUMENTS

90-B Tipu Road,
Small Industrial Estate,
51310 Sialkot- Pakistan

Phone: +92 308 8154772

Email: info@dentistainstruments.com

Website: www.dentistainstruments.com